



Bobcat®

One Tough Animal®

DIESEL FORKLIFTS

9-Series, Pneumatic, 6 to 9 ton capacity

🌐 EMEA



ONE TOUG ANNIM

► **OUR MISSION**

We empower operators to accomplish more, while working in the toughest conditions and tightest situations. When our customers have the will, we provide the way.

INTRODUCTION

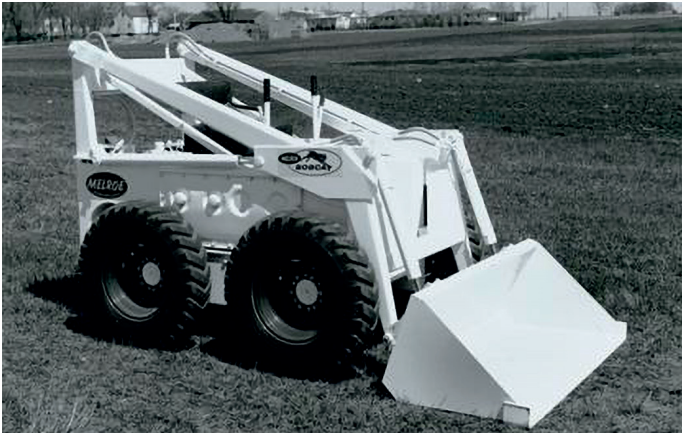

▶ BOBCAT'S HISTORY

In 1958, Melroe Manufacturing Company introduced a compact front-end loader that evolved quickly into the M400, the world's first true skid steer loader. The company soon adopted what became the world-famous 'Bobcat' brand – and its success paved the way for the global compact equipment industry we know today.

▶ YEARS OF EXPERIENCE

In 2021, Bobcat expanded its portfolio by acquiring Doosan Industrial Vehicle. This specialist in material handling equipment constructed its first forklift in 1968 and went on to establish a global presence with 400 dealers in 93 countries.



▶ BOBCAT TODAY

Bobcat is further expanding its portfolio with the addition of forklifts and reach trucks for the material handling industry. Offering a comprehensive line-up that will meet all your intralogistics needs. Bobcat forklifts and reach trucks are produced in our factory in Korea, while our premium quality warehouse equipment is made in Germany.



9-Series Diesel Forklifts 3

W A L

TOUGH, AGILE & SAFE

► DESIGNED FOR PRODUCTIVITY

With high-performance engines, fluid, intuitive controls, superior operator comfort, and a host of safety features, Bobcat D70S 9-Series forklifts are ready to boost the productivity of your business while keeping spending in check thanks to a low cost of ownership.



► POWERFUL AND EFFICIENT

Get more done daily thanks to high-performance engines with a 3-speed auto-shift transmission providing 55 or 81 kW of power to boost productivity in every task.
P. 6-7



► COMFORTABLE ALL SHIFT LONG

Enjoy the comfort of a spacious cab with plenty of leg room, deluxe suspended seat, integrated instrument panel, tiltable steering column, and many more features.
P. 8-9

Fuse and relay box located in front of the engine makes maintenance easier

Good visibility through the roof enhances precision and safety while lifting
P. 8

Equipped with a rear-view camera for improved visibility, enhancing safety in the work environment
P. 10



Anti-slip step plate for increased safety when getting in & out of your machine

3 multi-torque modes available for the best performance
P. 7



► SAFETY FIRST

Protect your investment, workforce, and handled goods. Excellent all-around visibility, ground speed control, and a host of other safety features come as standard.

P. 10-11



► RUGGED RELIABILITY

Experience a synergy of power, performance, and functionality with features like an IP67-rated connector, oil-cooled disk brakes, and upgraded cooling performance suitable for all tasks.

P. 12-13



OUTSTANDING PRODUCTIVITY



▶ SEAMLESS SHIFTING

Elevate your driving experience with our electronically controlled 3-speed auto-shift transmission. Benefit from automated optimal shifts, heightened fuel efficiency, and optimized power matching. Featuring a self-diagnostic system, it embodying the pinnacle of efficiency and performance.

▶ CUSTOM MODES

Different torque modes can be chosen to suit your working environments. The Eco mode optimizes fuel consumption by enhancing fuel efficiency. The Standard mode is suitable for typical tasks, while the High mode enhances the truck's workability for heavy-duty operations.



▶ PERFORMANCE AND EFFICIENCY

The 3.4 L DM03V engines, equipped with a Bosch Common Rail System, are the best-in-class engines on the market. Our 55 kW (no Ad Blue needed) and 81 kW engines not only offer low fuel consumption but top-notch gradeability and travel and lifting speeds as well. Keep your TCO low thanks to an auto-tension belt-drive system and a hydraulic lash adjuster, and also improved exchange cycles for the fuel filter and engine oils (1 000 hours).

▶ OIL-COOLED DISC BRAKES

Enjoy oil-cooled disc brakes for better braking and faster cycles, giving you the confidence to navigate and stop quickly. This enhancement significantly speeds up task completion and boosts overall productivity.

COMFORT & CONTROLS



▶ IMPROVED VISIBILITY

Benefit from improved visibility in all working positions, thanks to a wider mast window, repositioned hydraulic hoses, and a flat bar-style overhead guard.



▶ SUSPENSION SEAT

The suspension seat is designed for comfort, offering a larger seat back angle, extended seat travel length, and operator's weight resistance on the front side, allowing for multiple adjustments to create the most comfortable seating experience.



▶ SPACIOUS OPERATOR COMPARTMENT

The cab has the perfect height and interior space for ample leg room and overall comfort. The adjustable steering column, and ergonomic operator pedals ensure ease of entry and exit.



▶ LOW NOISE LEVEL

The pressurized cab prevents dust entry and features 2 large air filters for a clean air supply. It also maintains very low noise and vibration levels for high driving comfort.

▶ THE PERFECT TEMPERATURE



Work comfortably in any weather thanks to the integrated heating/cooling/ventilation system (HVAC), which allows you to control the temperature inside the cab.

▶ EASY ACCESS



This forklift features a low step height, facilitating easy and safe entry and exit, complemented by an easy entry grab bar and an anti-slip step plate.

▶ FULL-COLOR DISPLAY



The 7-inch full-color display is strategically positioned at eye level for enhanced comfort. It offers excellent outdoor visibility and provides comprehensive updates on the machine's status, keeping the operator well-informed.



SAFETY IN EVERY MOVE

▶ ADVANCED PROTECTION FOR YOU AND YOUR OPERATION

Bobcat forklifts have safety embedded in their DNA. Packed with tons of features that protect your health and your investment, these machines give you peace of mind in every task, every day.

▶ REAR DETECTOR

Receive real-time alerts when objects are detected behind the forklift for a safer work site.



▶ ELECTRIC PARKING BRAKE (EPB)

The parking brake engages automatically. This safety feature keeps the vehicle stationary when the seat is exited.

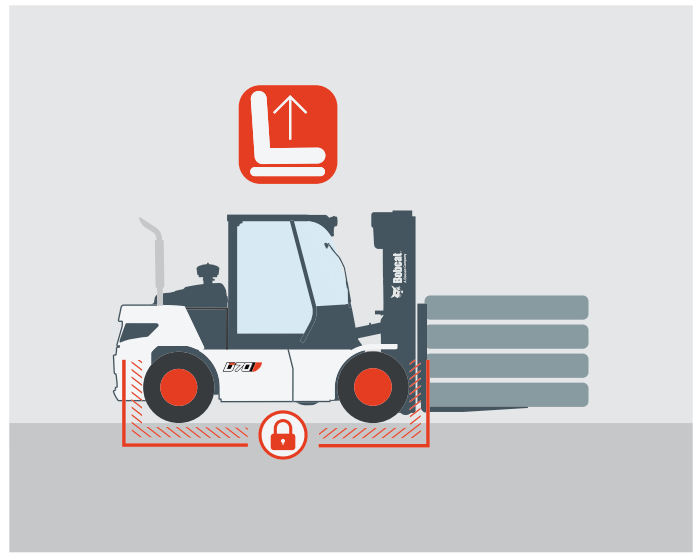

▶ ANTI-SURGE FUNCTION

Maintain the forklift's stability and prevent sudden shifts or movements, especially when carrying heavy or unbalanced loads.

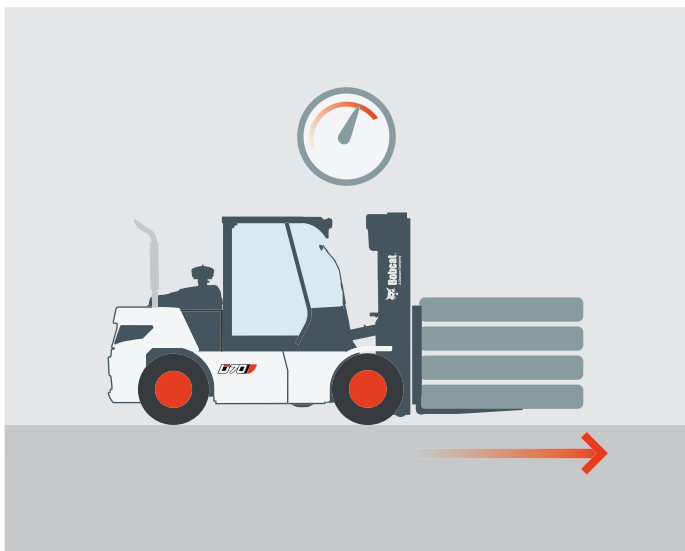

▶ GROUND SPEED CONTROL

Enhance safety by setting a speed limit to prevent your forklift from going too fast. The speed limit can be set separately for forward and reverse directions.

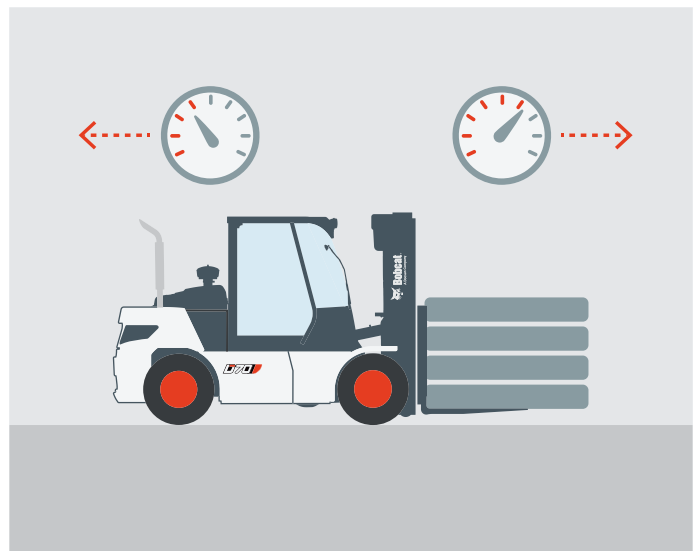

▶ BACK-UP ALARM

The back-up alarm emits a warning signal when driving in reverse, alerting those nearby and further ensuring safety in the workplace.



▶ WEIGHT SCALE

With our weight indicator and scale options, you never second-guess if you're overloading your forklift or taking unnecessary risks.



▶ BRIGHTER AND SAFER

Experience a brighter, safer, and more efficient workday with our front lights, combination lamps, and additional rear lights.



▶ REAR-VIEW CAMERA

The front and rear-view cameras provide a better view of surroundings, avoiding collisions with objects and pedestrians and ensuring a safer work environment.



BUILT TO LAST

▶ A HERITAGE OF RELIABILITY

Bobcat forklifts embody the combination of robustness and reliability – these machines allow you to focus on your business without worrying about your fleet.



**THERE'S NO TIME
FOR DOWNTIME.
STAND UP TO EVERY TASK
THAT COMES YOUR WAY.
DAY AFTER DAY.**

2 YEAR WARRANTY

► WARRANTY

Bobcat develops every machine to the highest standards of quality and durability. That's why our standard warranty provides 24 months or 2 000 operating hours (whichever occurs first) of coverage.

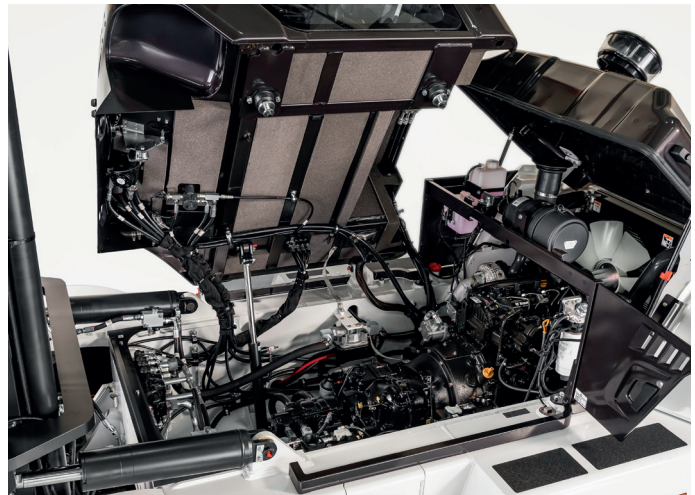

► PROTECTION PLUS EXTENDED WARRANTY

Enjoy total peace of mind with Protection Plus extended warranty. Providing the same level of protection as the standard warranty, Protection Plus also reflects different customer needs and expectations by offering a choice of durations and annual operating hours.

► EXTENSIVE DEALER NETWORK

You can rely on our network of dealers and service partners who are always ready to help you.

► BOBCAT GENUINE PARTS

Quality components delivered to our dealers guarantee that all of our equipment is built to last, withstand the toughest conditions, and provide reliable performance.

MAIN SPECIFICATIONS

TECHNICAL DATA ACCORDING TO VDI 2198							
		D60S-9		D70S-9		D80S-9	D90S-9
Drive				diesel			
Load capacity (kg)	Q	6 000		7 000		8 000	9 000
Load center (mm)	c			600			
Load distance: center of drive axle to fork (mm)	x	632					725
Wheelbase (mm)	y	2 300					2 500
Tread, front (mm)	b11	1 584					1 668
Tread, rear (mm)	b12	1 550					1 750
Tilt of mast / fork carriage forward / backward (°)	α/β			15 / 10			
Height, mast lowered (mm)	h1	2 440 – 4 445					2 630 – 4 735
Free lift (mm)	h2	205 – 2 540					215 – 2 570
Max. fork height (mm)	h3	3 000 – 7 275					3 100 – 7 650
Height, mast extended (mm)	h4	4 075 – 8 295		4 275 – 8 295			4 375 – 8 925
Height of overhead guard (mm)	h6	2 468					2 673
Height of seat (mm)	h7	1 455					1 526
Overall length (mm)	l1	4 818		4 897		5 214	5 240
Length to forkface (mm)	l2	3 618		3 697		4 014	4 040
Overall width (mm)	b1/b2	2 156					2 230
Fork dimensions (mm)	s/e/l	60 × 800 × 1 200					700 × 1 800 × 1 200
Fork carriage width (mm)	b3	2 156					2 216
Ground clearance, loaded, below mast (mm)	m1	196					283
Ground clearance, center of wheelbase (mm)	m2	214					329
Aisle width for pallets 1 000 × 1 200 crossways (mm)	Ast	5 212		5 262		5 575	5 605
Aisle width for pallets 800 × 1 200 lengthways (mm)	Ast	5 412		5 462		5 775	5 805
External turning radius (mm)	Wa	3 380		3 430		3 650	3 680
Travel speed, loaded / unloaded (km/h)		30.7 / 34.7	30.8 / 34.3	28.6 / 34.5	30.2 / 34.2	30 / 35	
Lift speed, loaded / unloaded (mm/s)		470 / 530	500 / 540	410 / 470	440 / 480	430 / 480	
Lowering speed, loaded / unloaded (mm/s)				500 / 450			
Max. drawbar pull, loaded / unloaded (kg)		6 705	7 928	6 723	7 878	7 360	7 328
Max. gradeability, loaded / unloaded (%)		49 / 95	61 / 100	43 / 85	52 / 100	40 / 78	35 / 75
Engine manufacturer / type		DM03V(P)	DM03VA	DM03V(P)	DM03VA		
Engine power according to DIN ISO1585 (kW)		55.4	80.9	55.4	80.9		
Rated speed (min ⁻¹)				2 300			
Max. torque (Nm/rpm)		400 / 1 300	460 / 1 400	400 / 1 300	460 / 1 400		
Number of cylinders / displacement (- / cm ³)				4 / 3 409			

*Specification values quoted in this specification sheet have been rounded.
 Performance may vary depending on operating conditions.
 Products and specifications are subject to improvement and change without prior notice.
 (1) Mast dimensions refer to a range from the lowest to highest available mast with load backrest.

Note: Load capacities are based on the standard chassis without side shifter.

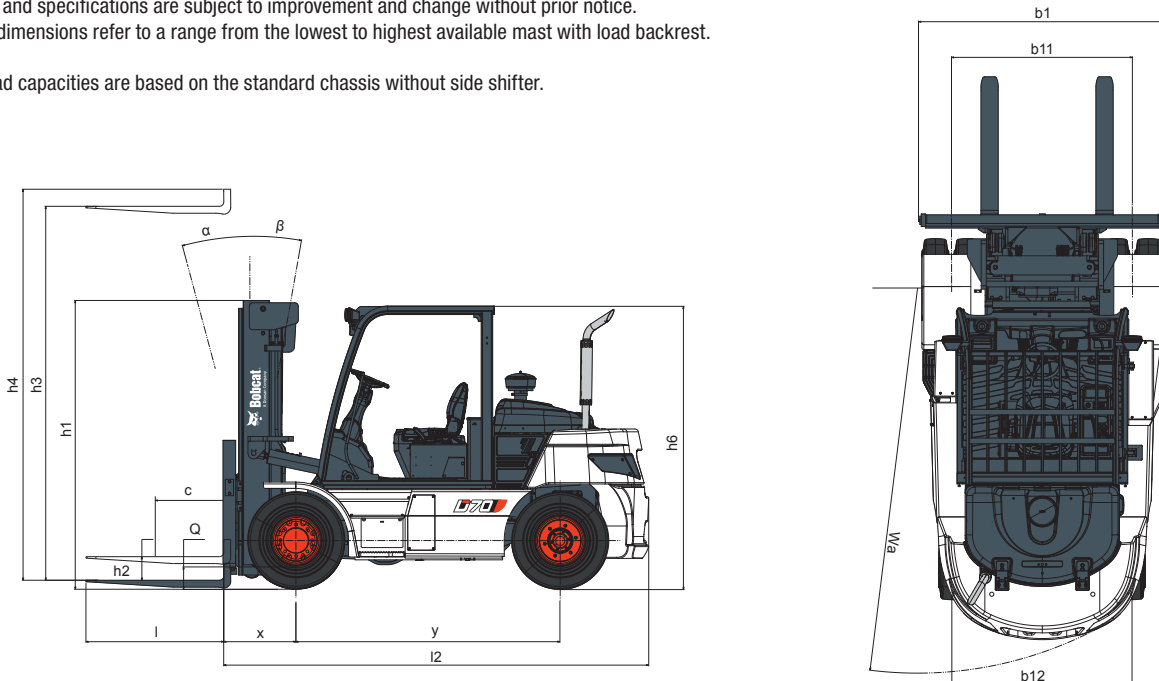

STANDARD EQUIPMENT & OPTIONS

STANDARD EQUIPMENT & OPTIONS	
PRODUCTIVITY	
Power steering	✓
High powered, fuel efficient engine	✓
Multi Torque Mode	✓
Powershift Transmission	✓
2 front LED lights	✓
Auto throttle up	✓
Vehicle control unit (VCU)	✓
Auto tilt levering	•
Autoshift controller	•
2 rear LED lights	•
Additional 2 front LED lights (on cab or on mast)	•
Combination LED lights (with hazard switch)	•
Push button to start with pin code	•
Strobe light (above/below)	•
Rotating strobe light (above, LED)	•
Radial tires	•
SAFETY	
Electric Parking brake	✓
Overhead guard	✓
Back-up alarm	✓
Rear-view mirror (LH/RH)	✓
Panoramic mirror	✓
Safety light (always on or activated by gear)	•
Seat belt interlock	•
Load backrest	•
4 th lever interlock for attachment	•
Front camera, rear-view camera	•
Weight indicator (hydraulic/load cell)	•
Anti-surge function	•
GUARDIAN STABILITY SYSTEM (GSS)	
Operating Sensing System (OSS)	✓
Ground speed control	✓
Unlimited ramp hold	✓
Low battery alarm	✓
Rear object detection system	•

STANDARD EQUIPMENT & OPTIONS	
ERGONOMICS	
Excellent visibility	✓
Large entry grip bar	✓
Anti-slip step plate	✓
Telescopic steering column	✓
Convenience tray	✓
Steering wheel knob	✓
Large rear-view mirror	✓
Key switch	✓
7-inch display	✓
Rear grab bar with horn	✓
Power jack (12V 5AMP) & USB port	✓
Suspension seat with arm rest	✓
Fingertip option	✓
Grammer, air suspension, arm rest, heating	•
Full cab	•
Heater & air conditioner	•
Audio (DAB type Radio, MP3)	•
Tool kit	•
Operator fan	•
RELIABILITY	
Oil-cooled disc brakes (ODB)	✓
Anti-moisture electric connectors	✓
Additional cooler (hydraulic/transmission oil)	•
Radiator screen	•
Under protection (belly plate)	•
Pre-fuel filter	•
Mud guard (rear tire)	•
Pre-cleaner	•
SERVICEABILITY	
Dual element air cleaner and rain cap	✓
Centralized fuse and relay box	✓
Tilttable operator compartment	✓
Easy to access the components	✓
EasyView	✓
Tankless air compressor	•
Steer axle common wheel (with wheel nut cover)	•

*This list is based on factory data.
Standard or optional can vary for specific countries.

• = option
✓ = standard
– = not available

FINANCING OPTIONS

24, 36, OR 48 MONTH FINANCING*

Take advantage of 24, 36 or 48 month financing programs starting from **0% interest** and improve your cashflow. Ask your dealer for the financing offers available.

340 MACHINES / 150 ATTACHMENT FAMILIES / 1 TOUGH ANIMAL

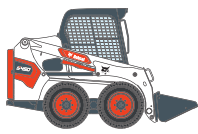

**SKID-STEER
LOADERS**



**COMPACT TRACK
LOADERS**

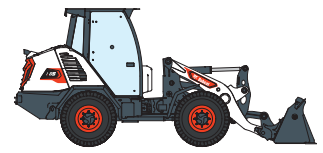

**COMPACT WHEEL
LOADERS**



FORKLIFTS

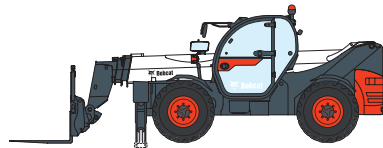

TELEHANDLERS

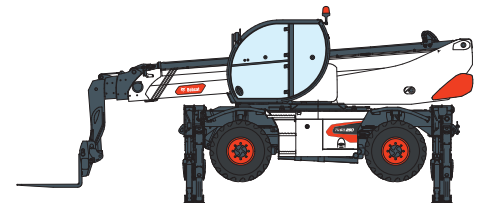

ROTARY TELEHANDLERS



**LIGHT COMPACTION
EQUIPMENT**

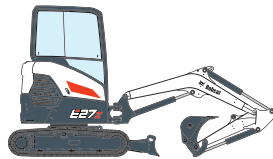

**COMPACT
EXCAVATORS**



**COMPACT
TRACTORS**



**SMALL ARTICULATED
LOADERS**



**MINI TRACK
LOADER**



MOWERS

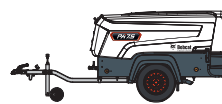

**PORTABLE
POWER**



ATTACHMENTS



Bobcat®

DOOSAN

Bobcat is a Doosan Company. Doosan is a global leader in construction equipment, power & water solutions, engines, and engineering proudly serving customers and communities for more than a century. | Bobcat and the Bobcat logo are registered trademarks of Bobcat Company in the United States and various other countries. ©2024 Bobcat Company. All Rights Reserved.

*Financing options may vary by country and dealer. Always ask your dealer about currently available financing options. Terms and conditions may apply.

Doosan Bobcat EMEA, U Kodetky 1810, 263 12 Dobříš, Czech Republic

www.bobcat.com

©2024 BOBCAT B4502690-EN (03-24)